

Flexible Design and a variety of Controllers

Yamaha provides a versatile range of remote control options to suit the various installation types as well as the customer's unique requirements. These range from simple wall panel remotes to fully customizable software based control for either iOS or Windows based platforms.

	ProVisionaire Control	ProVisionaire Control KIOSK	ProVisionaire Touch	ProVisionaire Touch KIOSK	MCP1	DCP	Wireless DCP
UI Design	✓	-	✓	-	-	-	-
Control	✓	✓	✓	✓	✓	✓	✓
Signal Processor MTX, MRX series	✓	✓	✓	✓	✓	✓	✓
Power AMP XMV series	✓	✓	✓	✓	-	-	-
Power AMP MA/PA series	-	-	-	-	-	✓	-
Digital Mixer CL, QL, TF series	✓	✓	✓	✓	-	-	-
I/O device Exi/o, R series	✓	✓	-	-	-	-	-
MusicCast ¹	-	-	✓	✓	-	-	-
Blu-ray Disk Player ²	-	-	✓	✓	-	-	-
Disklavier™ ENSPIRE ³	-	-	✓	✓	-	-	-
Support OS	Windows	Windows	iPad	iPad	Hardware	Hardware	iPhone, iPod touch, iPad, Android

Supported devices

¹: CD-NT670, CD-NT670D, WXA-50, WXC-50, MusicCast compatible AV receiver

²: BD-A1060, BD-S681

³: YUS1ENST, YUS1Wh-ENST, YUS1MhC-ENST, YUS3ENST, YUS3Wh-ENST, YUS3MhC-ENST, YUS5ENST, YUS5Wh-ENST, YUS5MhC-ENST, C1X-ENST, C2X-ENST, C2XCP-ENST, C3X-ENPRO, C5X-ENPRO, C6X-ENPRO, C7X-ENPRO

Related products



SIGNAL PROCESSOR MRX7-D



MATRIX PROCESSOR MTX Series



INPUT EXPANDER EXi8



OUTPUT EXPANDER EXo8



MULTI-CHANNEL POWER AMPLIFIER XMV Series



DIGITAL MIXING CONSOLE CL Series



DIGITAL MIXING CONSOLE QL Series



DIGITAL MIXING CONSOLE TF Series



DIGITAL MIXER TF-RACK



I/O RACK R Series (AD/DA)



I/O RACK Tio1608-D



DIGITAL CONTROL PANEL DCP Series



WALL MOUNT CONTROLLER MCP1

Related Software



MTX-MRX Editor



Wireless DCP



* Wireless DCP can be downloaded from Apple's App Store and Google Play at no charge. (Apple, iPhone and iPod are trademarks of Apple Inc., registered in the U.S. and other countries. App Store is a service mark of Apple Inc. Android and Google Play are trademarks of Google Inc.)

YAMAHA CORPORATION
P.O. BOX 1, Hamamatsu Japan

www.yamaha.com/proaudio

*All specifications are subject to change without notice.

*All trademarks and registered trademarks are property of their respective owners.



SHARING PASSION & PERFORMANCE



CUSTOM CONTROL PANEL

ProVisionaire Control ProVisionaire Touch



Flexible Design and a variety of Custom Control Panels

Yamaha provides a versatile range of remote control options to suit the various installation types as well as the customer's unique requirements. These range from simple remotes to fully customizable software based control for either iOS or Windows based platforms.

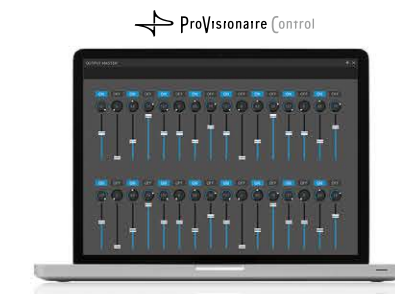

ProVisionaire Control



Customizable control panel software for Yamaha PA system (Windows)

By simply dragging and dropping widgets such as faders and switches onto a screen, you can create an ideal original control panel dedicated to the applications and functions required for an installation project. No programming know-how or experience is necessary. ProVisionaire Control can control a wide range of Yamaha PA equipment such as MTX/MRX Series signal processors, CL/QL/TF Series digital mixers, the Rio Series I/O boxes and the XMV Series power amplifiers. ProVisionaire Control offers a total Yamaha control solution.

- Intuitive and simple approach to design flexible controllers
- Customized remote control of Yamaha PA systems
- User Level Access Control
- ProVisionaire Control KIOSK

Basic procedure: setup to operation

Step 1: Controller Design



Create a layout with widgets that perform the functions of faders and switches, and assign them to the required control devices.

Step 2: Check & Delivery

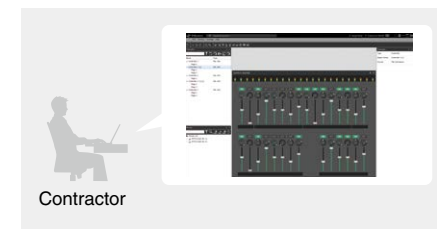

By using the controller function of ProVisionaire Control, use it as an actual controller to check the appearance and usability.

Step 3: Operation

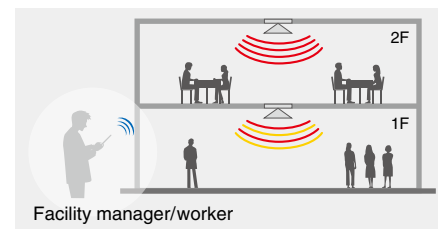

Once the system is online, all compatible devices can be controlled. The tablet device can be mounted on a wall or other fixed surface, or used handheld for maximum remote control freedom and convenience.



Intuitive and simple approach to design flexible controllers

Microphone and CD player volume faders, ON/OFF switches and other widgets can be freely arranged on the design page with drag and drop operation. ProVisionaire Control provides an easy, intuitive way to create original controllers that are ideally configured for the target installation. Multiple design pages are available so that different control panels can be provided for different audio zones and/or users, with presets and parameter settings optimized for each.

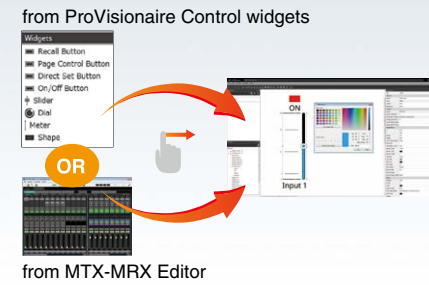

Customized remote control of Yamaha PA systems

ProVisionaire Control can operate a wide range of Yamaha PA products. Choose the product parameters (Mixer Fader, Channel select, Amplifier volume so on) from the ProVisionaire Control widgets and drag and drop them on to the screen. ProVisionaire Control makes it easy to combine several Yamaha PA equipment's parameters allowing operation from a single screen. You can unify the management all the Yamaha PA equipment.



User Level Access Control

ProVisionaire Control has four user level management functions. By utilizing this function, it prevents controller users from accessing the operating system so that unintended control or design changes cannot occur.

Role/User	Administrator	Power User	Staff	Guest
Release the screen lock	✓	✓	✓	-
Operation	✓	✓	✓	-
Reading and switching controller files	✓	✓	-	-
Reading a project file	✓	-	-	-
Edit design	✓	-	-	-

ProVisionaire Control KIOSK

Windows PC/Tablet to be set up to function as a dedicated controller

This software allows the Windows PC/Tablet to be set up to function as a dedicated controller, preventing users from accessing the operating system or other applications so that unintended control or design changes cannot occur. Operation widgets, such as faders and switches, and monitor functions are consolidated onto one screen with ProVisionaire Control.

System Requirements

OS	Windows 10 (32bit/64bit)	Windows 8.1 (32bit/64bit)	Windows 7 (32bit/64bit)
CPU	Intel Atom/Core i or better		
Memory	2GB or more		
HDD/SSD	100MB or more		
Other	A system equipped with Ethernet (1000BASE-T or better) or Wi-Fi capability		

Dante network for AV presentation/BGM/Paging system (Enterprise/Education/Hotel Banquet)



- Aggregate in-house broadcasting and voice control of each area into MRX7-D system, and manage them all with Provisionaire Control.
- The volume of the Meeting Room is individually controlled by the control panel "MCP 1" installed in each room.
- Utilize digital mixer when more voice input and more detailed operations are required for panel discussion, lecture, band performance etc.

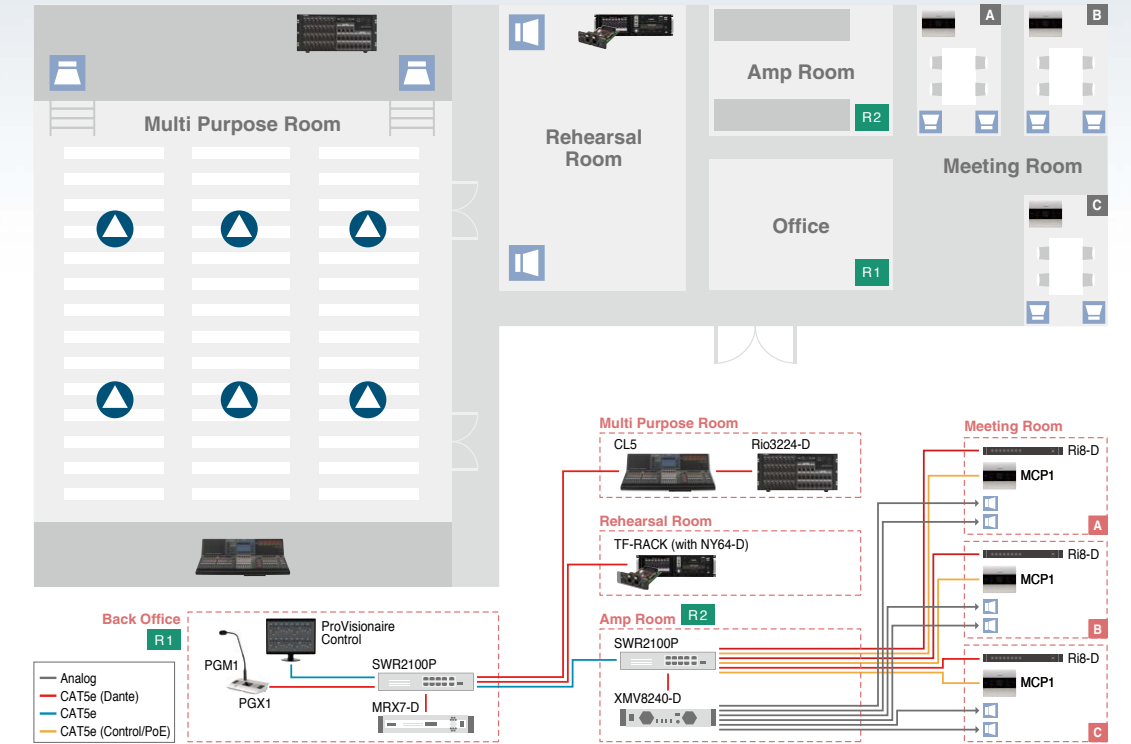

ProVisionaire Touch



Smart Looks and Flexible Design for Custom Wireless Control Panels (iOS)

ProVisionaire Touch is software that allows a Yamaha PA system to be remotely controlled from an iPad. The interface of the operating screens can be designed intuitively. Design does not require any special programming skill. Simply by dragging widgets such as volume control faders, switches, and photos into the design screen of your tablet, you can create custom control panels that are appropriate for your situation and users.

- An Intuitive Approach to Designing Flexible Controllers
- User Level Access Control
- File Export
- ProVisionaire Touch KIOSK

*Apple, iPhone, iPod touch and iPad are trademarks of Apple Inc. registered in the U.S. and other countries. App Store is a service mark of Apple. Inc.

Set up to control over a wide range of music and video content

A single iPad can be used to control a comprehensive range of music source by using MusicCast® compatible devices: CD players, NAS storage, mobile devices, Internet radio, Blu-ray Disc Players and AV receivers. In addition, ProVisionaire Touch supports the Yamaha Disklavier™ ENSPIRE, providing wireless remote control of automated acoustic piano playback as well as DisklavierRadio streaming.

- Step 1:** Create a layout with widgets that perform the functions of faders and switches.
- Step 2:** Connect all devices to a single network and enter the IP address of each device to allow control.
- Step 3:** Once the system is online, all compatible devices can be controlled.

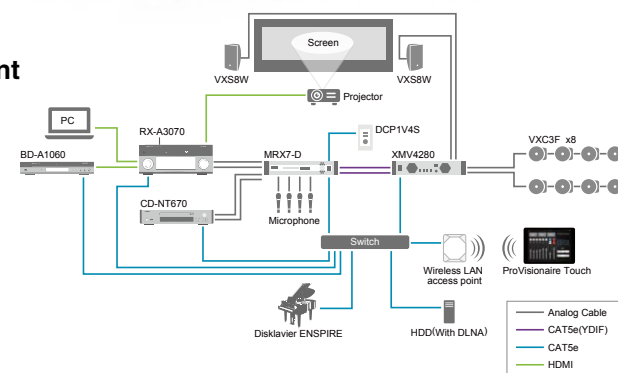

An Intuitive Approach to Designing Flexible Controllers

Microphone and CD player volume faders, microphone ON/OFF switches, photos, and other widgets can be freely arranged on the design page. ProVisionaire Touch provides an easy, intuitive way to create original touch controllers that are ideally configured for the target installation. Multiple design pages are available so that different control panels can be provided for different audio zones and/or users, with presets and parameter settings optimized for each.

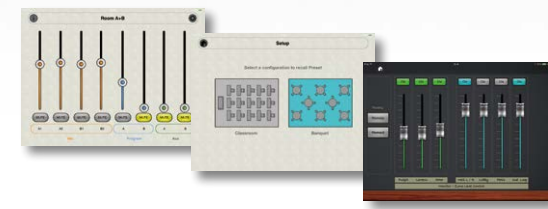

User Level Access Control

Access to the control panels and design pages is controlled by three passcodes for maximum security as well as operating convenience.

- 1: Pass-code for screen lock: To avoid the miss operation
- 2: Pass-code for power user: For advanced user to move to special page (s)
- 3: Pass-code for administrator: For the contractor to design control panel

	Screen Lock	Operate/Set	Edit/Adjust
System Administrator	✓	✓	✓
Owner/Staff	✓	✓	-
Guest User	✓	-	-

File Export

Completed control panels can be exported as data files. Exported data files can be saved and later used as templates when creating control panels for multiple iPads at the same installation, *or when setting up ProVisionaire Touch for a different installation.

*Up to 8 controllers can be assigned to a single MTX/MRX system.

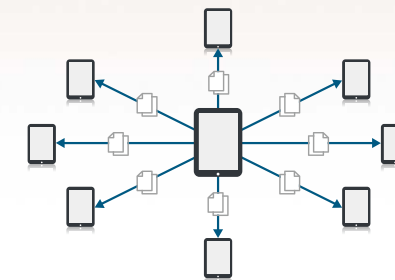

ProVisionaire Touch KIOSK

iPad to be set up to function as a dedicated controller

This app allows the iPad to be set up to function as a dedicated touch-panel controller, preventing end users from accessing the operating system or other apps so that unintended control or design changes cannot occur.

Compatible Devices : iPad (not including the first-generation model)
iOS : 9.0 or later

Simple presentation system control over the speech and video content

- The ProVisionaire Touch iPad application, which supports MTX3, XMV4280, MusicCastaudio devices, can be used for remote wireless ON/OFF switching, volume control.
- By combining MTX/MRX system with the MusicCast® compatible AV receiver and the Yamaha Blu-ray disc player, it is possible to select the music source, switch the HDMI input source with the AV receiver, and control the device including the video playback of the Blu-ray disc all together with one iPad.

